

XCL103D333CR-G Evaluation Board User Manual

Inductor Built-in Step-up “micro DC/DC” Converter (micro DC/DC)

CAUTION

ENGINEERING EVALUATION PURPOSES ONLY

This evaluation board is made for the purpose of the product evaluation.
It is strictly prohibited to use this evaluation board for any other purpose.

Torex Semiconductor does not guarantee that all samples will perform in exactly the same way and we recommend that you always consult our product data sheets for the minimum and maximum specifications.

It is also important that you evaluate all our products carefully before mass production and in case of any doubt, please contact your Torex

XCL103D333CR-G Evaluation Board

Inductor Built-in Step-up "micro DC/DC" Converter (micro DC/DC)

Evaluation Board Picture

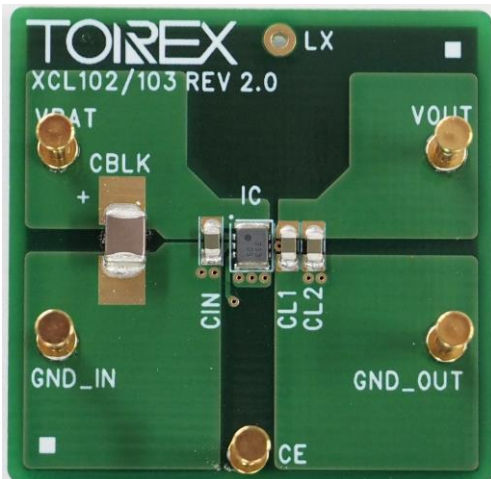

Evaluation Board SPEC

						Ta=25°C
		CONDITON.	MIN.	TYP.	MAX.	UNIT
Vin	Input Voltage Range	-	0.65	-	6	V
Vout	Setting Output Voltage	-	-	3.3	-	V
Iout	Output Current	-	Refer to Graph 7			mA
fosc	Switching frequency	-	-	3.0	-	MHz

XCL102/XCL103 Series Features

- Input Voltage Range 0.65V ~ 6.0V
- Output Voltage Range 2.2V ~ 5.5V (step 0.1V)
- Switching frequency 3MHz
- Small Solution Size

XCL103D333CR-G Evaluation Board

Inductor Built-in Step-up "micro DC/DC" Converter (micro DC/DC)

Quick Start Procedure

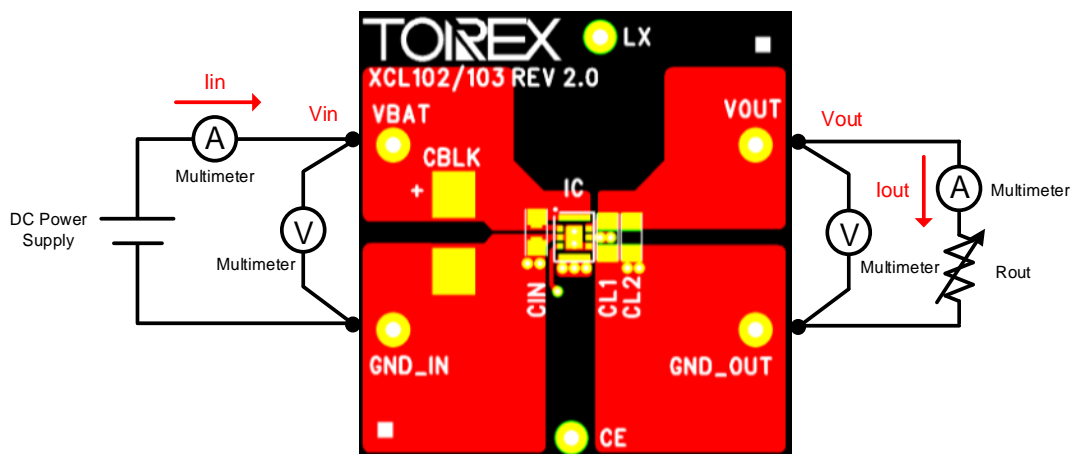

XCL103D333CR-G Evaluation Board

Inductor Built-in Step-up "micro DC/DC" Converter (micro DC/DC)

Schematic

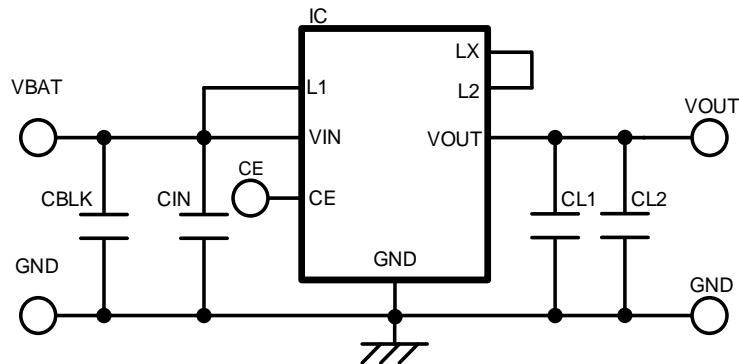

BOM

Required Circuit Component

Item	Value	Description	Size [mm]	Part Number	Manufacture
IC	-	Step-up micro DC/DC converter	CL-2025-02	XCL103D333CR-G	TOREX
CIN	10uF	Ceramic cap., 25V/10uF	1608	TMK107BBJ106MA-T	Taiyo Yuden
CL1	10uF	Ceramic cap., 25V/10uF	1608	TMK107BBJ106MA-T	Taiyo Yuden
CL2	10uF	Ceramic cap., 25V/10uF	1608	TMK107BBJ106MA-T	Taiyo Yuden

Additional Demo Board Circuit Components

Item	Value	Description	Size [mm]	Part Number	Manufacture
CBLK	10uF	Ceramic cap., 50V/10uF	3225	CGA6P3X7S1H106K	TDK

XCL103D333CR-G Evaluation Board

Inductor Built-in Step-up "micro DC/DC" Converter (micro DC/DC)

PCB Layout

Layer 1

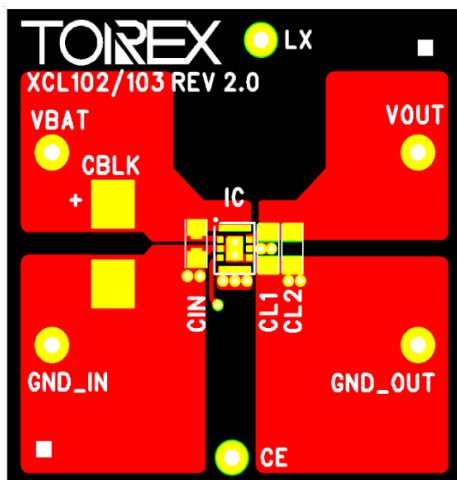

Layer 2

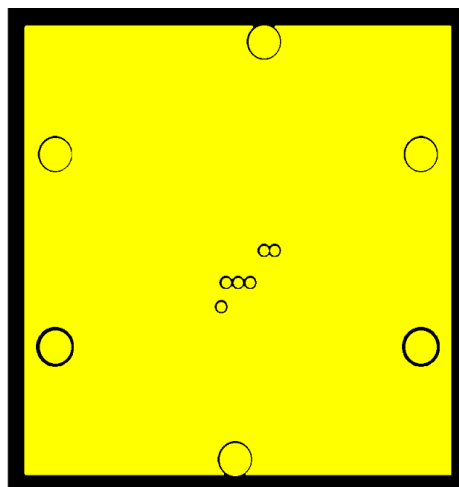

Layer 3

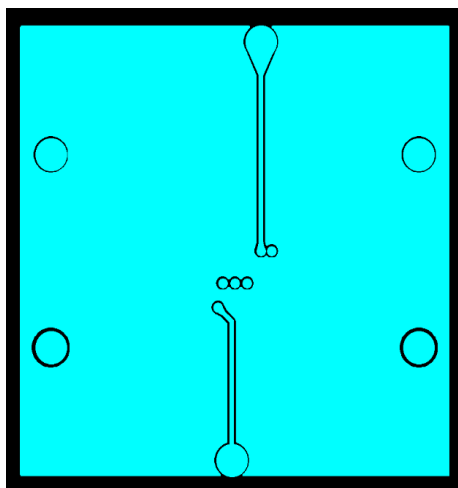

Layer 4

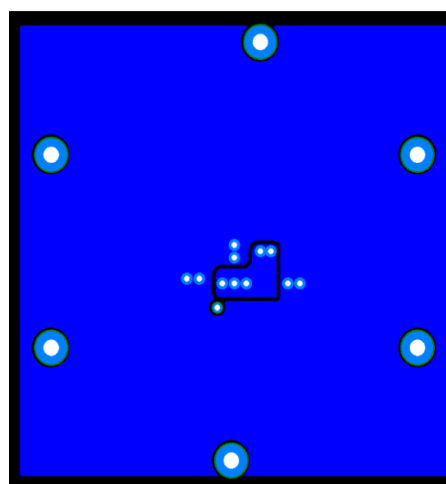

XCL103D333CR-G Evaluation Board

Inductor Built-in Step-up "micro DC/DC" Converter (micro DC/DC)

Test Result

(1) Output Voltage vs Output Current @Ta=25°C

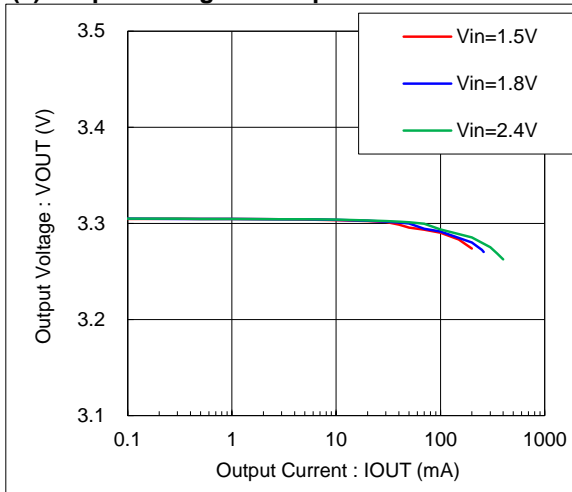

(2) Efficiency vs Output Current Ta=25°C

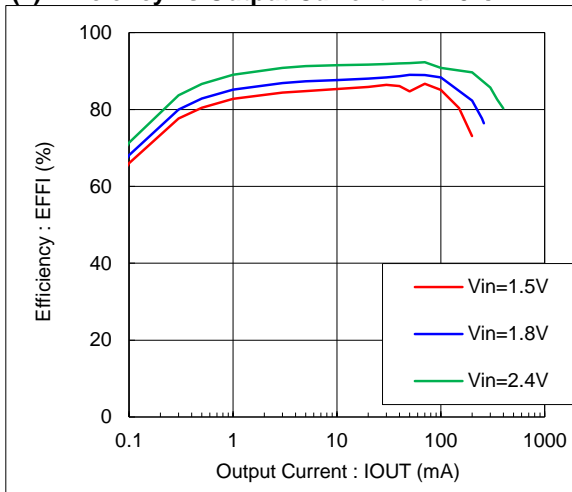

(3) Ripple Voltage vs Output Current Ta=25°C

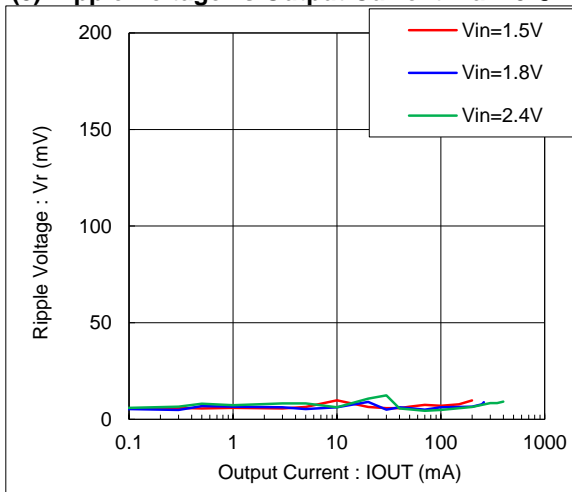

XCL103D333CR-G Evaluation Board

Inductor Built-in Step-up "micro DC/DC" Converter (micro DC/DC)

Test Result

(7) Max Output Current vs BAT Voltage(Input Voltage) @ Ta=25°C

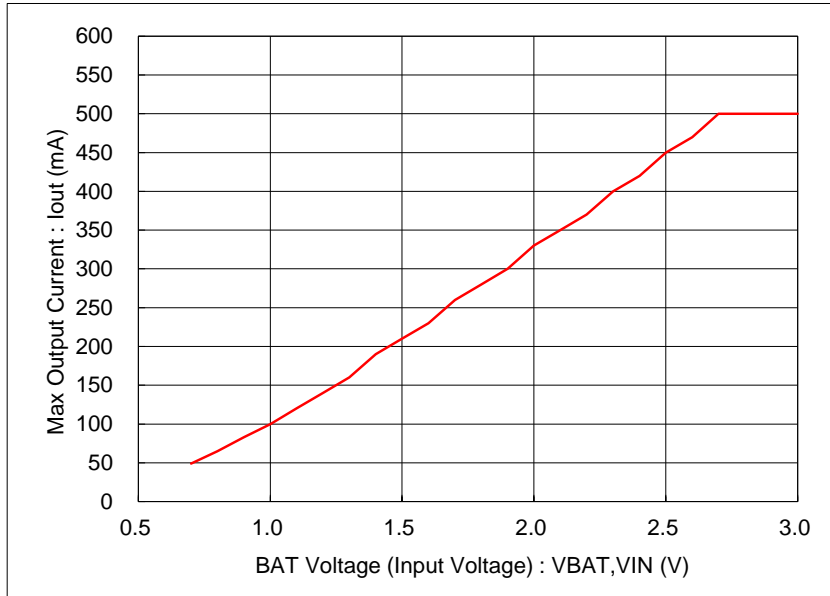

XCL103D333CR-G Evaluation Board

Inductor Built-in Step-up "micro DC/DC" Converter (micro DC/DC)

Test Result

(7) Radiation EMI : CISPR-32/VCCI 10m Peak

Condition

IC : XCL102D333CR-G
 Vin : 2.4V
 Vout : 3.3V
 Iout : 100mA

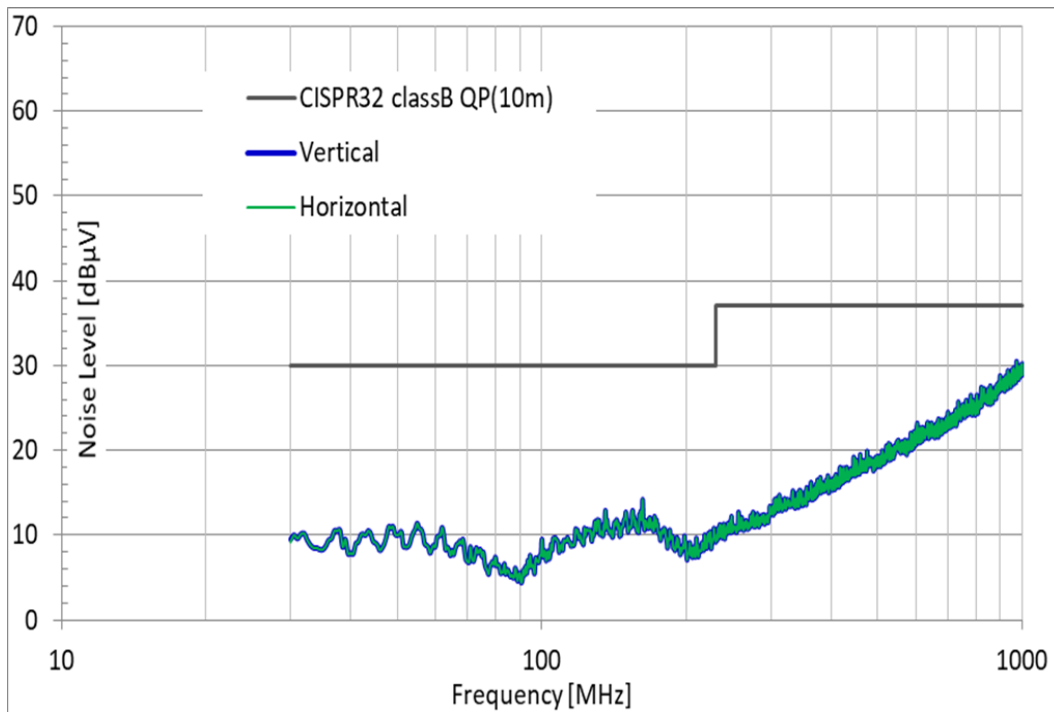

XCL103D333CR-G Evaluation Board

Inductor Built-in Step-up "micro DC/DC" Converter (micro DC/DC)

【Appendix】How to calculate DC/DC Converter or DC/DC Controller.

It can be calculated by the following "WEB DC/DC Simulation".

Product	XCL103 Product Info	Schematic Summary	Waveform	Efficiency Tj, Duty	Ripple Voltage Vin Voltage	Coil Current Input Current	Switching frequency
Switching frequency	3000 [kHz]	<p>本結果はICばらつきを考慮しないTYPでのデータです。 ICの製造ばらつきにより、本結果より最大出力電流が低下する場合があります。</p>					
Control Method	PWM/PFM	<h3>Efficiency</h3>					
Sim Condition							
Vin	2.5 [V] Range: 0.65V~6V	<h3>Loss Ratio</h3>					
Vout	3.3 [V] Range: 2.2V~5.5V						
Iout	100 [mA] Range: 0mA~						
Rvin (Battery Impedance etc)	0 [Ω]						
Ta	25 [°C] Range: -40~85°C						
Thermal resistance: θja	100 [°C/W] Range: 0~1000°C/W						
External Components							
CL (Effective Value)	5 [μF]						
ESR	5 [mΩ]						

- 日本語 : <https://www.torex.co.jp/technical-support/dcdc-simulation/>
- English : <https://www.torexsemi.com/technical-support/dcdc-simulation/>
- 简体中文 : <https://www.torex.com.cn/technical-support/dcdc-simulation/>

XCL103D333CR-G Evaluation Board

Inductor Built-in Step-up "micro DC/DC" Converter (micro DC/DC)

【Appendix】 How to reduce the spike noise caused by measurement (Probing method with oscilloscope)

Probing method : Before improvement

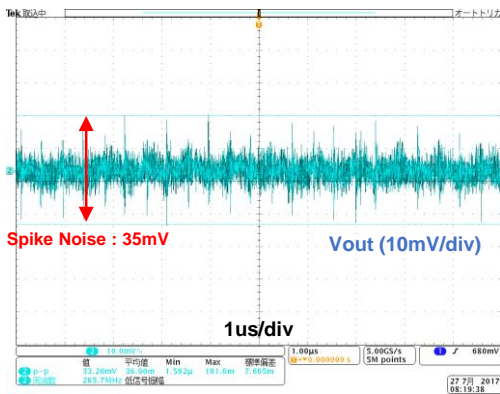
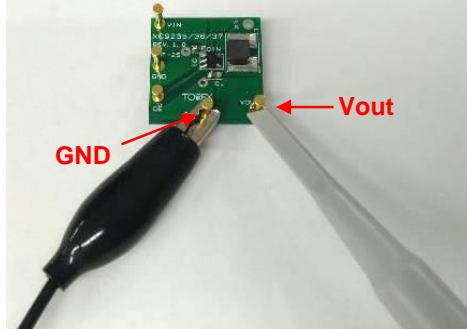

Probing method : After

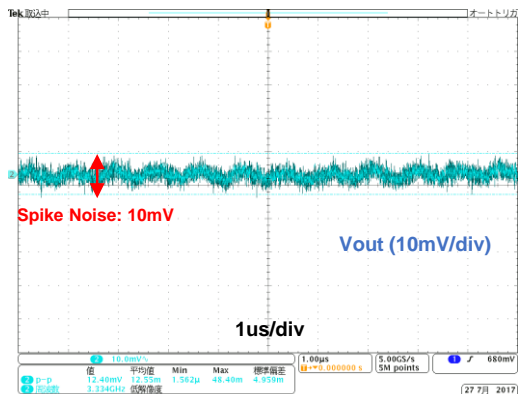
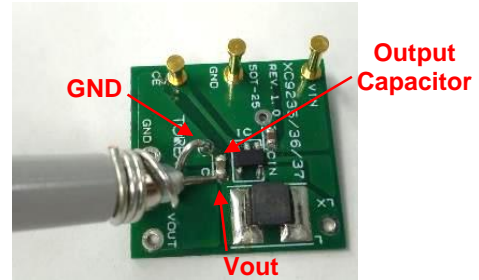

* Condition : XC9236, Vin=3.6V/Vout=1.8V/100mA

English : <https://www.torexsemi.com/technical-support/tips/reduction-spike-noise/>

日本語 : <https://www.torex.co.jp/technical-support/tips/reduction-spike-noise/>