

Torex...Powerfully Small!

HiSAT-COT[®] control
600mA Synchronous Step-down DC/DC converters
XC9290/XC9291 Series

Nov. 2023
TOREX Semiconductor Ltd.
Rev. 1.1

World's smallest solution area / Low consumption

■ Features

Input Voltage	: 2.5V ~ 6.0V (Absolute Max.: 7.0V)
Output Voltage	: 0.7V ~ 3.6V (Accuracy: ±2.0%)
Output Current	: 600mA
Oscillation Frequency	: 4.0MHz, 6.0MHz
Efficiency	: 90% ($V_{IN}=3.7V$, $V_{OUT}=1.8V$, $I_{OUT}=200mA$)
Control Method	: HiSAT-COT F-PWM (XC9290) PWM/PFM (XC9291)
Functions	: Soft-Start UVLO C_L Discharge (Type B)
Protection	: Current Limit
Packages	: LGA-6B01, WLP-5-08
Operating Ambient Temp.	: -40°C ~ 105°C

■ Typical Application Circuit

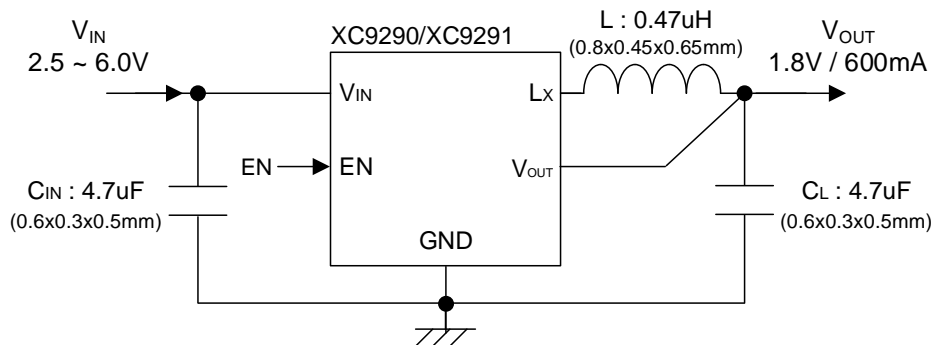

■ Packages

LGA-6B01
(1.2x1.2x0.3mm)

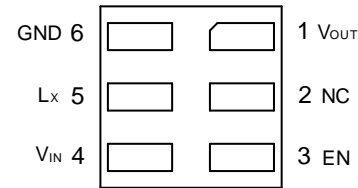

WLP-5-08
(0.96x0.88x0.3mm)

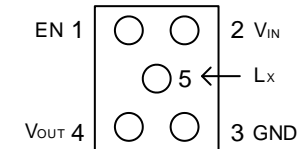

■ Ultra Small Size

- World's smallest solution 3.15mm²
- 0.6 x 0.3mm Ceramic Capacitors
- 0.8 x 0.45mm Inductor



- World's smallest solution area with fast transient response / Low noise / High efficiency

**Ultra small
HiSAT-COT®
600mA Step-down DC/DC
XC9290 / XC9291**



Mount Area
1.5x2.1mm=3.15mm²

World's smallest
2.1 x 1.5 mm
= 3.15mm²

Fast transient
Low noise

① Adapted to the smallest external components.

- ✓ 0.8x0.45mm Inductor (world-first)
- ✓ 0.6x0.3mm Ceramic Capacitor
- ✓ High efficiency despite being the world's smallest and 6MHz.

② Fast transient, Low ripple, Low EMI

- ✓ High speed transient response with HiSAT-COT control
- ✓ Low ripple voltage even with 0.6x0.3mm size low effective ceramic capacitor
- ✓ Ultra-low EMI equivalent to Built-in inductor DC/DC due to minimized layout.

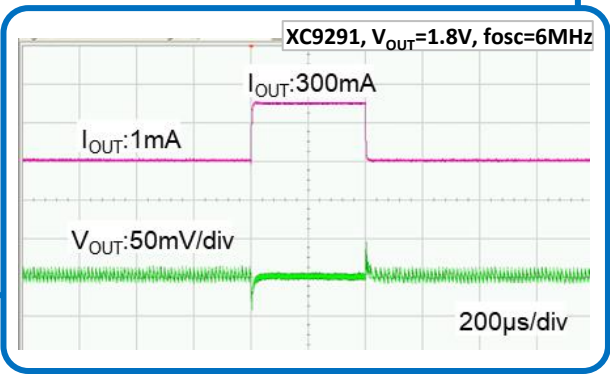
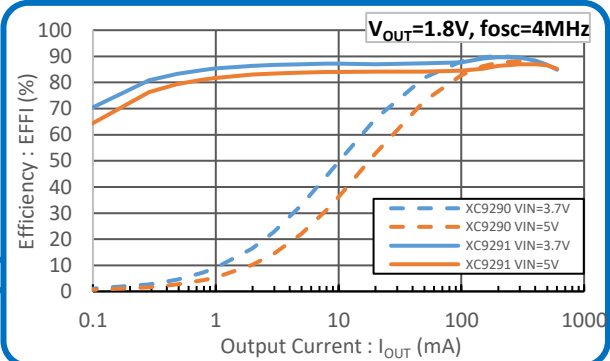

The world's smallest solution for further miniaturization of equipment/modules requiring high efficiency and low noise.

- Wearable/Hearable devices : TWS, Hearing aid, Headset, VR, Tracker, Medical monitoring
- Modules/Sensors : Camera modules, Wireless modules, SSD, Miniature sensors

0.6 x 0.3mm ceramic capacitors

- Stable operation even with ultra-small ceramic capacitors with small effective capacitances.

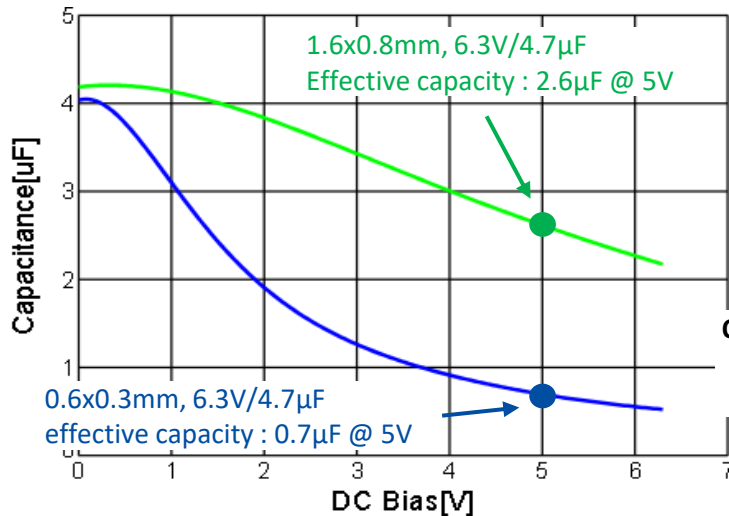

Operates with low effective capacity

DC/DC output voltage with 0.6x0.3mm ceramic capacitors

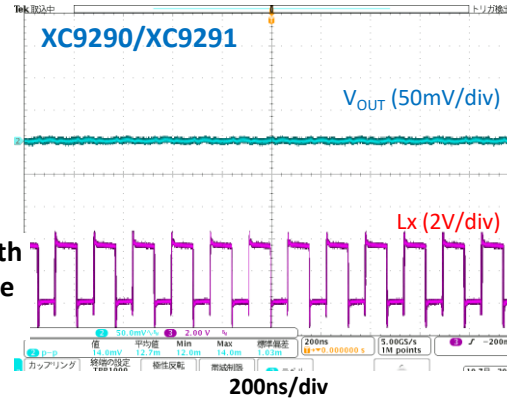

stable operation

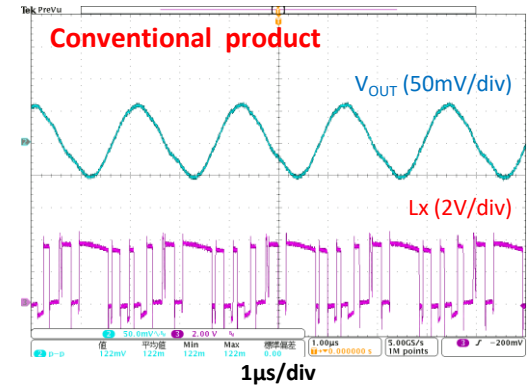

abnormal oscillation

World's smallest 0.8 x 0.45mm Inductor

- Stable operation with low inductance, so it can be used with ultra-small inductors.

* **0.8 x 0.45mm Inductor** : TDK, PLE856CBAR47M-1PT (06/2024 Mass production scheduled)

For the sample, please contact Sho.Uchida@tdk.com

Sho Uchida

TDK Corporation

IC Collaboration Dept. Marketing Strategy Group.

Electronic Components Business Company

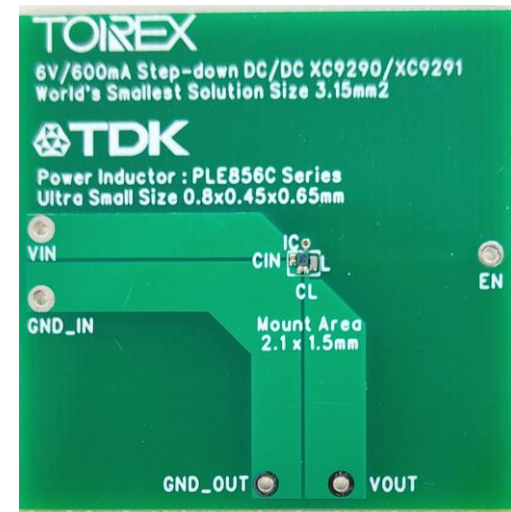

Low EMI & Low noise

- Low magnetic field leakage to the surroundings and minimal influence on peripheral devices during high-density mounting.

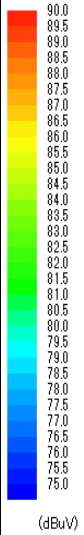
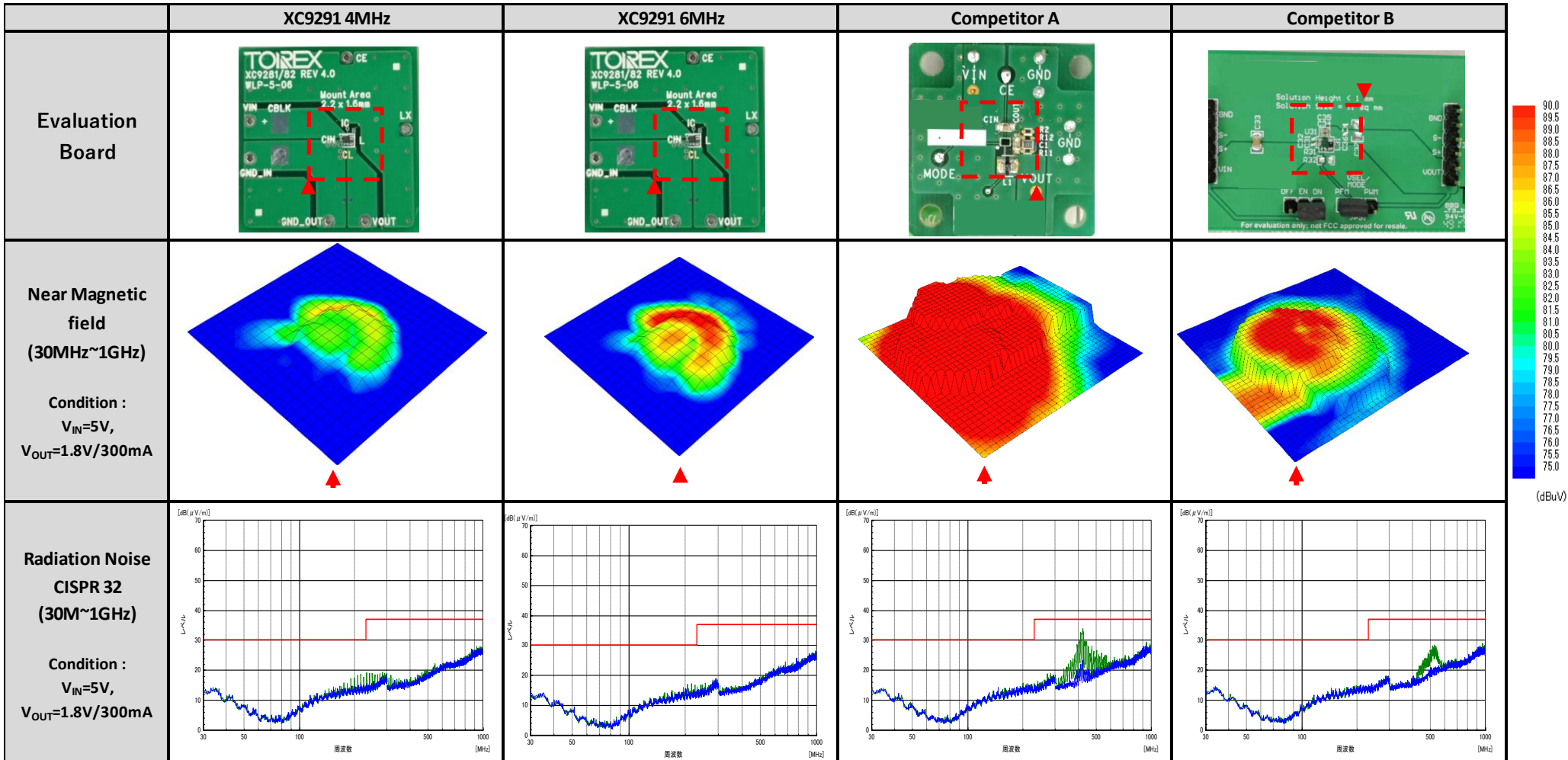

■ TOREX original COT control : HiSAT-COT[®]

● Technical trend and challenges

- Stable power supply including transient response to MCU/SoC/FPGA, etc.
- Miniaturization of circuits including peripheral components, and low EMI.

● TOREX Proposal : HiSAT-COT[®] controlled Step-down DC/DC converter

➤ Significantly faster transient response

- Compared to conventional PWM and PWM/PFM control, it achieves **overwhelmingly fast response** and thus **good voltage stability**.

HiSAT-COT[®] $V_{IN}=5V, V_{OUT}=1.8V, I_{OUT}=1mA \rightarrow 1A$

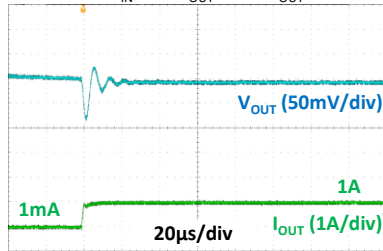

Conventional $V_{IN}=5V, V_{OUT}=1.8V, I_{OUT}=1mA \rightarrow 1A$

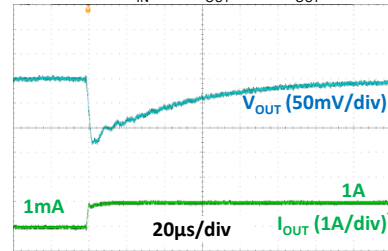

➤ Miniaturization including peripheral components

- High-speed transient response enables **significant reduction of large capacitance** required due to lack of response of conventional PWM.
- Unlike conventional PWM phase compensation, load capacitance CL can be reduced. Also **supports a significant reduction in effective capacitance due to the bias effect of ultra-small Ceramic capacitors**.

HiSAT-COT[®]



Conventional

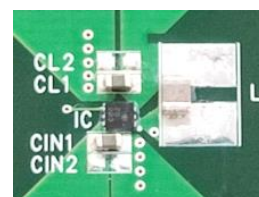

Overview of COT control and HiSAT-COT[®]

What is the COT (Constant on time) control?

- PFM control with the "ton" determined by V_{IN} and V_{OUT} voltages, resulting that appears to be PWM control with constant frequency (f_{osc}). **High-speed PFM comparator enables fast transient response.**
- Generate "ton" in CCM of the targeted f_{osc} from the V_{IN} and V_{OUT} set voltages so that it appears to be a constant frequency PWM control.

● CCM (Continuous Conduction Mode) operation

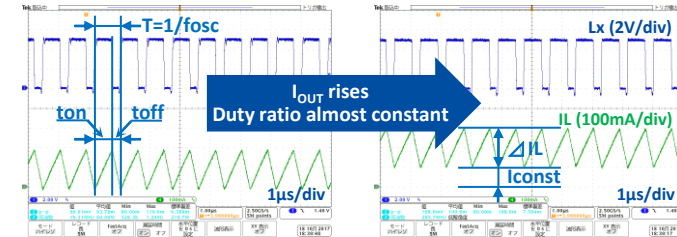

- Duty ratio of step-down DC/DC PWM operation above a certain I_{OUT} is **Duty ratio = V_{OUT}/V_{IN} , $ton = 1/f_{osc} \times \text{Duty ratio}$.** If there is no loss, **Duty ratio is constant** even if I_{OUT} rises.

● How to determine the oscillation frequency of COT control

- Generate the ton of COT control to be the ton of ideal PWM control.
- Continuous mode operation with this ton operates with the same duty as PWM control at the oscillation frequency f_{osc} .

● COT issues and HiSAT-COT[®]

HiSAT-COT improves the issues of COT control with its own circuits.

- Improved issue of increased oscillation frequency due to output current.
- Improved the deterioration of load stability with an original circuit with an additional amplifier.

Torex...Powerfully Small!